



AC30 Variable Speed Drive

For Open and Closed-Loop Applications
0.75 - 450 kW Standard Drive



ENGINEERING YOUR SUCCESS.



WARNING – USER RESPONSIBILITY

FAILURE OR IMPROPER SELECTION OR IMPROPER USE OF THE PRODUCTS DESCRIBED HEREIN OR RELATED ITEMS CAN CAUSE DEATH, PERSONAL INJURY AND PROPERTY DAMAGE.

- This document and other information from Parker-Hannifin Corporation, its subsidiaries and authorized distributors provide product or system options for further investigation by users having technical expertise.
- The user, through its own analysis and testing, is solely responsible for making the final selection of the system and components and assuring that all performance, endurance, maintenance, safety and warning requirements of the application are met. The user must analyze all aspects of the application, follow applicable industry standards, and follow the information concerning the product in the current product catalog and in any other materials provided from Parker or its subsidiaries or authorized distributors.
- To the extent that Parker or its subsidiaries or authorized distributors provide component or system options based upon data or specifications provided by the user, the user is responsible for determining that such data and specifications are suitable and sufficient for all applications and reasonably foreseeable uses of the components or systems.

Product Overview

Feature Overview.....	5
Modular System Overview	8
Control Module Options	9
System Design - Power.....	10
System Connectivity.....	12
Applications	14
Total Life-Cycle Support.....	15
Energy Savings	16
Industry 4.0.....	17
Single-Axis Applications	18
Multi-Axis Applications	19
Parker Drive Quicktool (PDQ) Software.....	20
Parker Drive Developer (PDD) Software.....	21

Technical Characteristics..... 22

Electrical Characteristics.....	23
Environmental Characteristics	23
Standards and Conformance.....	23
Dimensions	24
Connections	25

Accessories and Options..... 28

Operator Keypad.....	28
Cablescreening Kits	28
Input and Output Cards.....	29
Communication Interfaces.....	31

Product Configuration..... 33

Control Modules and Options.....	33
Power Stack.....	34
AC30V Complete Drives.....	35

Variable Speed Drive - AC30 Series

Overview

Description

The AC30 variable speed drive has been designed to provide users with exceptional levels of motor control, from simple open-loop pumps and fans through to closed-loop process line applications.

The AC30 combines advanced performance with exceptional ease of use, making even the most complex applications simple to achieve.

Working with the five principles of Flexibility, Simplicity, Reliability, Connectivity and Capability our engineers have created a product focussed on making the benefits of quality motor control available to every business.

Parker provides easy to use software tools for all levels of experience; enabling users to address any application. Simple applications can be setup in seconds and more complex applications can be configured in the simplest and most logical way. Programming can be via the keypad, DSELite, Parker Drive QuickTool software or the Codysys based Parker Developer with full IEC 61131 PLC Functionality.

The AC30 provides users with access to a large library of application macros and worked examples. While users are free to develop their own applications, they can also save time and development cost by accessing and customising examples of completed solutions.

To enable connectivity into a wide range of automation systems the AC30 features Profinet and Ethernet IP through dual Ethernet ports, as well as Modbus TCP IP with client and server functionality. That makes the AC30 series compatible with more than 80 percent of automation architecture; there is no need for expensive add-ons or upgrade modules.

The Ethernet protocols also provide potential for intelligent data analytics and connection to external servers – opening up links to the cloud or big data functionality.

So whether for standalone use or for integration into a complex automation system, the AC30 offers an easy to use solution for both simple and advanced motor control applications.



Technical Characteristics - Overview

Ratings									
380-480 (±10 %) VAC Supplies Three Phase									
Normal Duty				Heavy Duty					
kW	hp	Output Current [A _{rms}]		kW	hp	Output Current [A _{rms}]		Frame	
		400 V	460 V			400 V	460 V		
1.1	1.5	3.5	3.0	0.75	1	2.5	2.1	D	
2.2	3	5.5	4.8	1.5	2	4.5	3.4	D	
4	5	10	7.6	3	4	7.5	5.8	D	
5.5	7.5	12	11	4	5	10	7.6	D	
7.5	10	16	14	5.5	7.5	12	11	E	
11	15	23	21	7.5	10	16	14	E	
15	20	32	27	11	15	23	21	F	
18.5	25	38	36	15	20	32	27	F	
22	30	45	40	18.5	25	38	36	G	
30	40	60	52	22	30	45	40	G	
37	50	73	65	30	40	60	52	G	
45	60	87	77	37	50	73	65	H	
55	75	105	96	45	60	87	77	H	
75	100	145	124	55	75	105	96	H	
90	125	180	156	75	100	145	124	J	
110	150	205	180	90	125	180	156	J	
132	200	260	240	110	150	205	180	J	
160	250	315	302	132	200	260	240	K	
200	300	380	361	160	250	315	302	K	
250	350	440	414	200	300	380	361	K	
280	450	530	520	250	400	480	480	L	
315	500	590	590	280	450	530	520	L	
355	550	650	650	315	500	590	590	M	
400	600	700	680	355	550	650	640	M	
450	650	790	770	400	600	700	700	N	

Designed with you in mind

Flexibility

A fully featured list of standard functionality along with the use of common control and option modules allows users to put the drive to work in many different open- or closed-loop applications.

Simplicity

From the clear and concise backlit LCD display to the easy to use programming software, AC30 has been engineered to make the process of commissioning, operating and maintaining the drive as easy as possible.

Reliability

Parker engineers have taken every possible step to reduce the likelihood of problems occurring, including a number of features in the AC30 that will ensure any loss of productivity is minimised and production restarted as safely and as soon as possible.

Connectivity

Its flexible and highly modular construction enables a wide range of communications and I/O modules to be easily added as required. This enables AC30 to be used in advanced applications including multiple drive configurations.

Capability

Integrated macros for a range of applications and PLC functionality enable more capable users to create sophisticated control that would previously have required a separate PLC. The AC30 can be integrated into even the most complex systems.



Engineered cooling improves reliability

- Intelligent design minimises force ventilation requirements
- Removable fan improves maintainability
- Isolated power stack cooling path reduces contamination of control electronics



Compact footprint, chassis or through-panel mounting

- Multi-position feet with keyhole slots for ease of mounting
- Reduced heat radiation allows side-by-side mounting



Unobstructed access to power and dynamic brake terminals

- Terminal covers removable with drive in-situ
- Dynamic brake switch fitted as standard
- Easy access to DC Bus connections



Suitable for harsh environments

- AC30 is conformally coated as standard and meets the requirements of environment classes 3C1, 3C2 (all defined substances) plus 3C3 and 3C4 for Hydrogen Sulphide (H₂S)
- DNV marine / offshore approval



Suited to all environments

- Internal EMC filter options up to C2 1st environment for use in commercial buildings
- CE marked to EN61800-5-1 and NRTL listed to UL508C and C22.2#14
- DC link chokes above 2.2 kW reduce harmonics to below IEC/EN61000-3-12 limits



Expandable I/O capabilities

- A range of option modules expand AC30 to accommodate application specific I/O
- High-performance, closed-loop control with pulse encoder or resolver feedback module
- Spring clamp terminals reduce installation time and risk of loose connections





IEC 61131 PLC functionality included

- Parker Drive Developer (PDD) software lets the AC30 take greater control of its surroundings and in some cases remove the need for a PLC altogether



Ethernet connectivity and in-built diagnostic web pages

- In-built web pages allow AC30 to be interrogated over the on-board Ethernet and Modbus TCP/IP connection



Simplified configuration and data storage with SD cards

- SD card simplifies firmware updates and allows drive configuration and data to be stored



Intuitive and easy to use, multi-function graphical keypad

- Remote mountable and easy to use tactile keypad makes drive setup and operation simple



Safe-Torque-Off (STO) for safety critical applications

- Protecting users and machinery against unexpected motor start-up in accordance with EN13849-1 at PLe Cat3 or SIL 3 to EN61800-5-2



Field-fittable communications

- Seamless integration into automation systems



Easy to setup and use

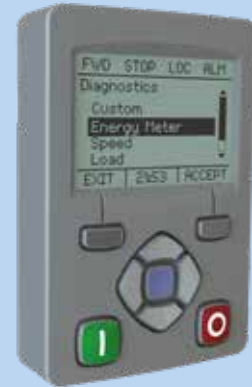

Graphical keypad

The tactile IP55 keypad can be mounted either on the drive itself or remotely and provides access to all drive functions.

The backlit LCD display can be configured to present information in any one of a number of different languages, or even in your own custom language with your own user-defined units.

PDQ

PDQ is a simple software tool for installing, programming and monitoring applications on the AC30 series variable speed drive. A simple wizard makes commissioning and maintain the drive application simple and easy for even the inexperienced operator.

PDD

PDD is a fully featured PLC programming tool for the AC30 series variable speed drive, supporting all IEC-61131 languages including ladder logic, structured text and function block diagrams. It provides access to all drive parameters and enables the user to create powerful AC30 drive solutions.

AC30 Series Variable Speed Drive

Overview

The AC30 is a modular product allowing users to select power stack, control module, IO and communications modules and accessories to perfectly match the requirements of the application, making it a highly customisable yet cost effective solution. The three interchangeable control modules provide the basis for the series: the standard AC30V control module, the AC30P module with a host of advanced connectivity options and the AC30D module which adds dual encoder system capability.

1) Select Power Stack

Power stacks range from 0.75 to 450 kW.

2) Select Control Module

A range of controls modules offer varying levels of intelligent automation control.

3) Select Comms & IO Options

A wide range of communications, fieldbus, IO and feedback options are available.

4) Choose accessories

Additional product accessories can be ordered to suit application and installation requirements.

AC30 Series Capability & Connectivity



AC30V

The AC30V is the base drive for standalone applications. Much more than a basic pump and fan drive its program can be modified with our easy to use “Parker Drive Quicktool” (PDQ) to match your exact requirements. The completed application program can then be downloaded multiple times using a simple SD card. With full access from any network via its own IP address the drive can be fully integrated into any automation system via the single, top-mounted ethernet port.

AC30P

Supporting latest developments in the “Internet of things” and employing principles discussed in Industry 4.0 the AC30P is fully equipped with Profinet, Ethernet IP and Modbus TCP/IP via dual Ethernet ports. Using the full range of our software tools this allows more advanced applications including multiple drive configurations. Plug in via one port and access multiple drives supported by 1588 time synchronised peer to peer communication.

AC30D

The AC30D module gives you the great features of the AC30P as well as additional built in terminals to allow dual encoder inputs and an encoder output. This gives “system Board” functionality to the AC30 allowing “electronic line shaft” capability so with this control module we can offer phase locking between drives and register control. This also frees up the I/O plug in slot to allow for even more I/O to be added if needed.

Feature	AC30V	AC30P	AC30D
Application Macros	Basic	System	System
Safety Torque Off (STO)	√	√	√
Modbus Server	√	√	√
Basic web server	√	√	√
Parker Drive Quick (PDQ) tool programming	√	√	√
DSE Developer software for legacy drive replacements	√	√	√
Ethernet IP	Option	√	√
Profinet	Option	√	√
Modbus client		√	√
System applications libraries		√	√
1588 time synchronised peer to peer comms		√	√
SMART diagnostics		√	√
User customisable web server		√	√
Parker Drive Developer (PDD) software (Codesys IEC61131)		√	√
Virtual master synchronisation (same as AC890)		√	√
Multi-axis phase locking (same as AC690/890)		√	√
Resolver feedback		Option	Option
Dual encoder inputs			√
Programmable encoder output			√

System Design - Power

Versatile Power Configurations

The AC30 Series can be configured to operate in a number of different power configuration modes to suit the exact requirements of your application. The modularity of the AC30 Series enables different combinations of system components to be easily selected and installed to achieve the desired design, eliminating significant amounts of pre-engineering work.

Building Blocks

AC30 Series is based on a variety of basic system power components which can be combined to create a number of different input power configurations. All variants are available in power ratings of 0.75 kW...450 kW.

Standard AC Inverter (710)

AC fed inverter suitable for use with a 380...480 VAC input. This can be used either as a standalone drive or as the AC input drive in a multi-drive application.



DC Fed Inverter (740)

DC fed inverter for use with a 500...700 VDC input. It can be used as a standalone drive where a suitable DC supply is available, or more usually as part of a multi-drive system.



Active Front End (AFE)

Both the 710 and 740 power stacks can operate in AFE control mode when used with the correct control module to provide a unity power factor, four-quadrant regenerative supply.



Line Regenerative Supply (380)

The Parker four-quadrant regenerative DC supply unit provides a low cost system power solution.



**Common DC Bus System
(supply from a single drive)**

Common DC bus system using a standard (710) inverter to supply the DC link. This design allows power sharing between drives, limiting the need for braking resistors. The power of the drives on the DC bus must not exceed double the power of the supply drive.

In all common DC systems the braking between drives is synchronised allowing brake resistors to be added to one or more drives to best fit the requirements of the application.

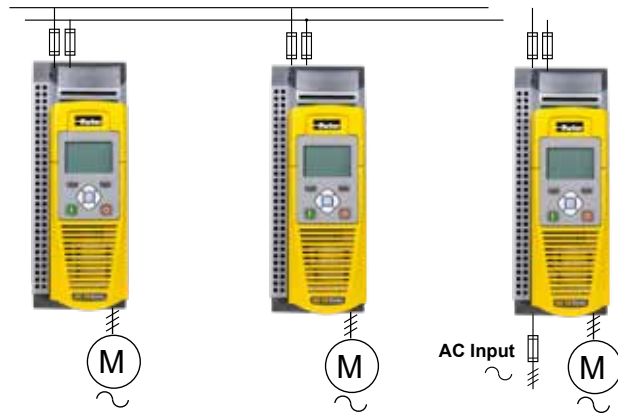

**Common DC Bus System
(supply to all drives)**

Common DC bus system using a standard (710) inverter with DC bus connection to all drives. This design allows power sharing between drives, limiting the need for braking resistors. Consideration is needed to include input chokes which can be required on each drive to balance the input currents between drives.

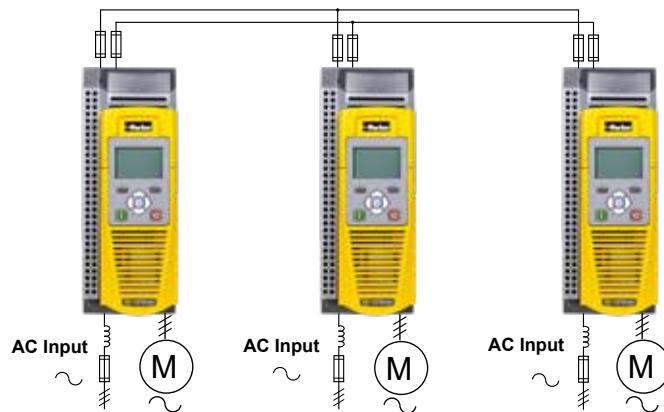

Common DC Bus System (Active Front End - AFE)

Common DC bus system using a 710 power stack and AC30P / D control modules to act as the AFE supply unit. The AFE must have the correct LCL filter to provide a pulse width modulated (PWM) controlled IGBT converter solution to allow bi-directional power flow to the AC line. The AFE is designed for applications with a high level of regeneration into the mains supply as no energy is wasted into braking resistors. The AFE solution also provides low harmonics, unity power factor and can provide voltage boost.

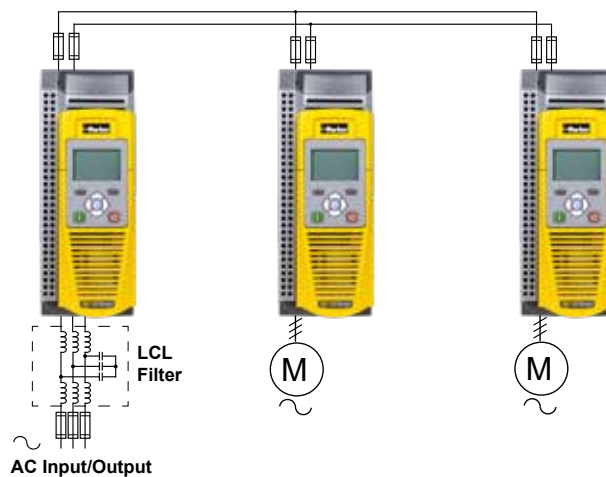

System Connectivity

The AC30 Series can be configured to operate in a number of different power control configuration modes to suit the exact requirements of your application. The flexibility of the AC30 Series enables our range of control modules to operate standalone or as an integral part of any automation architecture.

System Integration

The AC30 series can be easily integrated into your application supported by the wide range of connectivity options. AC30 series control modules can be programmed with our suite of software tools allowing users to configure the product to exactly match the application. Connectivity is provided via our hardware IO terminals offered on all control modules and expanded with our IO options or via standard and optional fieldbus modules.

Hardwired IO Configuration

The AC30 series offers analogue and digital inputs and outputs to maximise application compatibility. The IO can be expanded using 7004 option modules.

Our standard application macros set each IO point to a dedicated function. For customisation the IO can be configured to match your application using PDD or PDQ.



Fieldbus Configuration

Modbus TCP/IP is offered as standard on all AC30 control modules with profinet and ethernet IP on the AC30P and AC30D. Parker offer a wide range of communications options for easy integration into any automation network.



Peer to Peer Configuration

The standard ethernet on the AC30P/D offers peer to peer communication between drives. This allows for seamless data transfer. The peer to peer communication is 1588 time synchronised allowing phase locking between axis.



Parker Drive and HMI Network

The integrated PLC functionality inside the AC30 series allows applications to be programmed without a PLC. The IEC61131 flexibility and CODYSYS visualisation deliver a low cost automation solution.

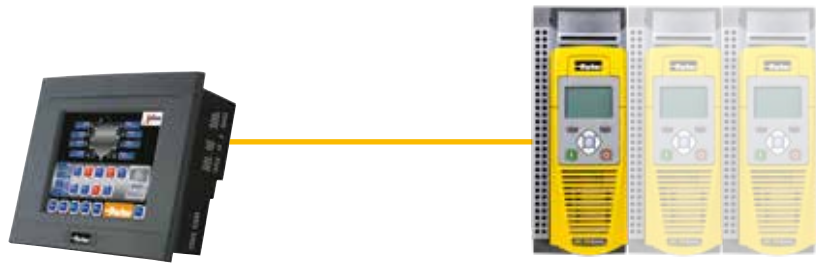

Parker Drive, PAC and HMI Network

For larger and more complex applications requiring a PLC, Parker can offer an intelligent cost-effective control solution. The AC30, PAC and PAC terminal can be programmed in a single software project.



Parker Drive and 3rd Party Ethernet PLC Network

The AC30 can be seamlessly integrated into a control architecture via Modbus TCP/IP, Profinet and Ethernet IP without the need for any additional options. The flexibility of the AC30 software allows simple connectivity to a wide range of Ethernet master controllers.



Parker Drive and 3rd Party PLC Network

The range of AC30 fieldbus options allow simple connectivity and integration into a wide range of control architectures.



Applications

With 40 years experience of designing and building AC and DC drives and systems, Parker has a wealth of expertise in a host of different industries. The AC30 has been built on this experience and incorporates many flexible and innovative features, making it ideally suited for use in many industrial and commercial applications. Additional communications, expanded I/O and pulse encoder / resolver feedback option modules extend the capabilities of the AC30 still further, making it an extremely flexible and capable solution for all types of open- and closed-loop motor control requirements.

Typical applications for AC30 include...

- Industrial Pumps
- Packaging Machines
- Textile Machine
- Machine Spindles
- Hydraulic Power Units
- Wire Drawings
- Converting Machines
- Printing Machines
- Test Stands
- Rolling Mills
- Crane Hoist Equipment
- Marine Winches
- Extruders



Industrial Pump Control



Offshore & Marine



Textile Machines

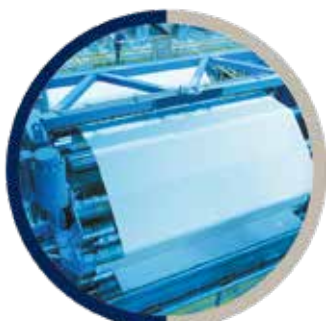

Converting



Machine Spindles



Rolling Mills

Total Life-Cycle Support

Parker is committed to providing total life cycle support for all of its electromechanical products. Our team of application experts can support customers through every stage of product ownership.



Simple and effective pump and fan control



Saving energy through speed control

Pumps and fans are widely used throughout industry. Some estimates suggest that a large proportion of these can be as much as 20 % oversized for the application they are used in. When these are operated at a constant speed, a significant amount of the power consumed by the motor is wasted, costing your company considerable amounts of money and creating additional CO₂ emissions.

Matching the speed of pumps and fans to process demands with the AC30V ensures that the motor will always operate at the optimal speed to deliver just the right amount of air or fluid. This can result in significant energy savings. A 20 % reduction in speed will actually reduce energy consumption by almost 50 % and payback can be achieved in **less than 18 months in many cases.**

Speed control = Savings

- Up to 50 % energy savings
- Improved power factor
- Reduced maintenance
- Quieter operation
- Increased service life
- Reduced carbon footprint

Improved power factor and service life

Pumps and fans that continuously operate at maximum speed inevitably have shorter life spans and are subject to unnecessary wear and tear. Variable speed drives can help improve service life while also reducing energy consumption and improving the power factor of your installations.

In addition to the cut in energy costs, you'll also see significant savings with maintenance and repair bills and a noticeable reduction in noise pollution as well.

Control by flow regulation, motor run at maximum speed

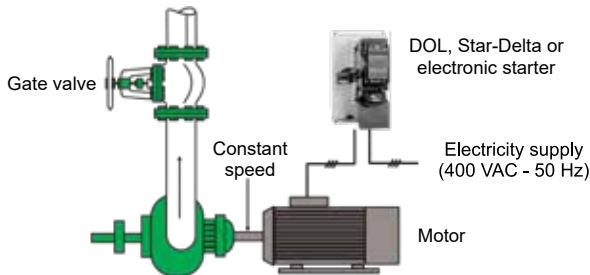

- Constant speed
- Power consumption higher than needed
- Poor power factor
- Higher energy costs
- Increased mechanical wear



€ 23 126/Year

= 22 kW x 8760 h x € 0.12/kWh

Control by AC30 variable speed drive

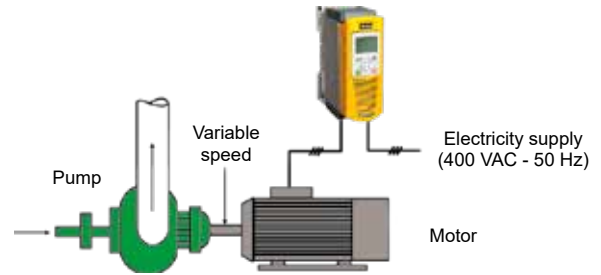

- Variable speed
- Power consumption is matched to load
- Improved power factor
- Reduced energy costs
- Reduced maintenance

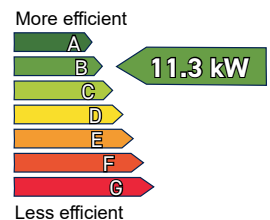

€ 11 879/Year

= 11.3 kW x 8760 h x € 0.12/kWh

Assuming a 20 % reduction in speed Power
= (.8 x .8 x .8 x 22 kW) = 11.3 kW

Total annual energy saving = € 11 247

AC30 and Industry 4.0

The collective term Industry 4.0 refers to the fourth industrial revolution, typically described as the computerization of manufacturing, the merging of traditional automation with information technology. One of the underlying concepts is modular cyber-physical systems that can collaborate with the operator and communicate between themselves in real-time to make autonomous decisions, thereby adapting production processes as needed.

Connected devices in factories, offices and on the person will become smart networked nodes, interconnected via a standardised network without any hierarchy. Better process optimisation, increased productivity, safety, reliability and flexibility, will all be highly valued outcomes from successful implementations of Industry 4.0.

The AC30 has been designed to be easily integrated as part of an Industry 4.0 system, connected either directly or via a PAC controller.

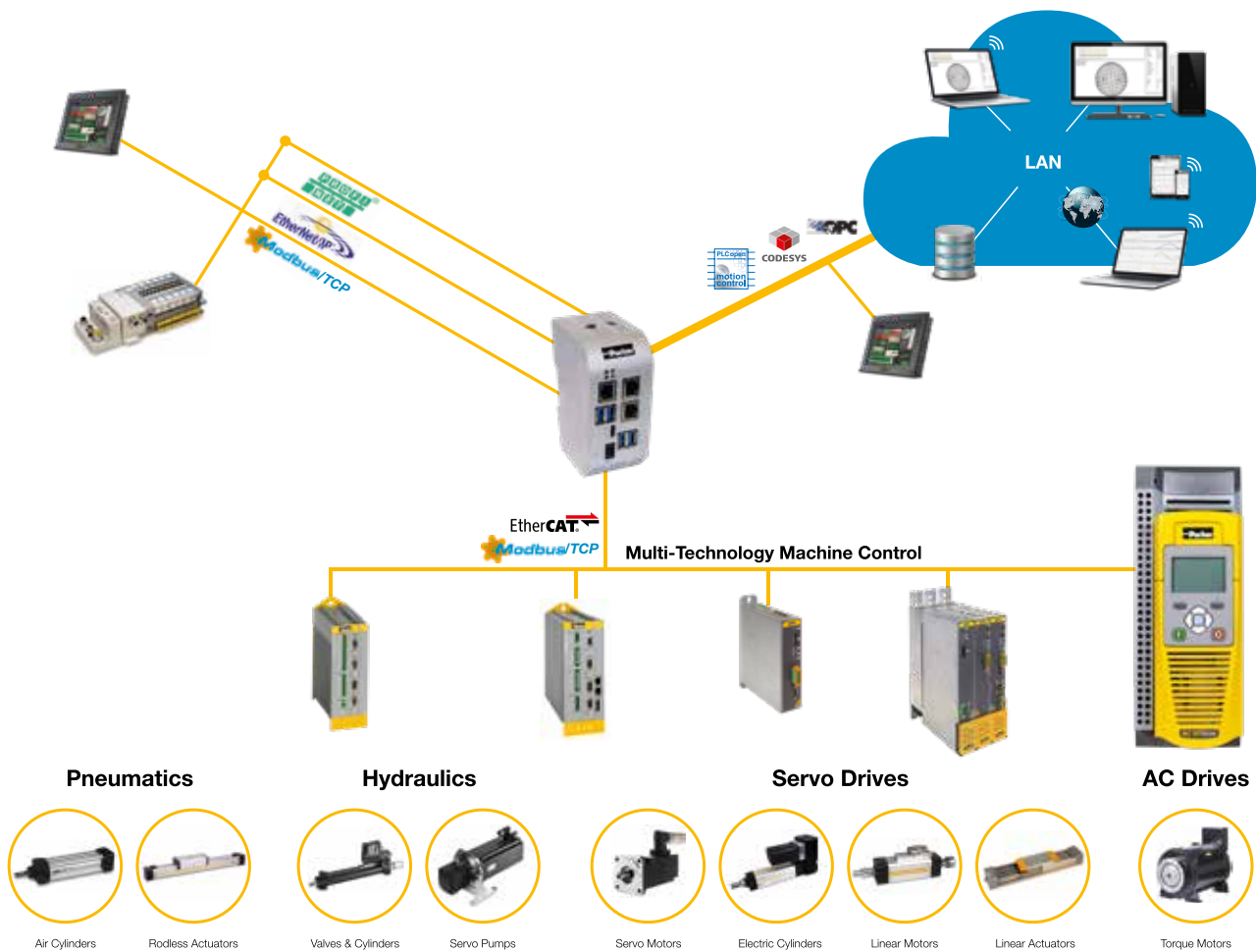

Single Axis Applications

Making use of pre-defined control logic, application macros enables users to quickly configure the AC30 for control of one of a number of pre-defined functions. Information is presented to the user in a template format which can then be simply and easily populated with the specific details of the application. This removes the complexity of designing the application logic from scratch.

Basic Speed Control

Set speed and voltage or current with start / stop direction control

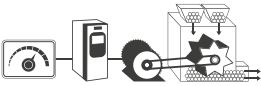

Automatic/Manual Control

Set to run with local speed setting or external reference

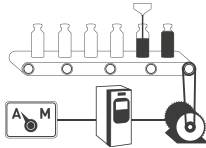

Raise / Lower

Increase or reduce speed using digital inputs

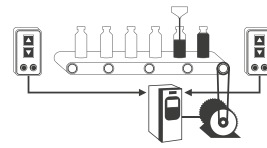

PID Control

Control the pressure, flow, temperature or any process variable

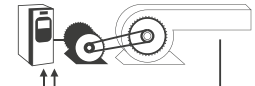

Pump Control

Dedicated pump control with specific pump functionality

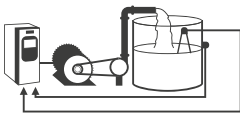

Torque Control

Control the motor torque limit using an analogue input

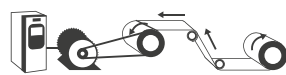

Hydraulic Pump Applications

Efficient control of hydraulic pumps for accumulator charging, pressure / flow control

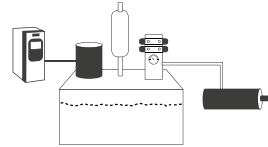

Preset Speed Control

Select up to 8 pre-programmed speeds using digital inputs

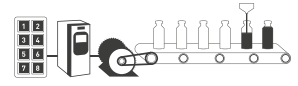

Engineered for any motor

In addition to the energy-saving associated with VSD control of pumps and fans. Additional energy saving can be achieved by using permanent magnet (PMAC) servo motors. AC30 offers effective and affordable control of either AC induction motors or PMAC motors.

PMAC motors are up to 10% more efficient and 75% smaller than standard AC induction motors.



Closed-loop operation

Optional pulse encoder and resolver feedback modules can be added to the AC30 for applications requiring more accurate speed or torque control of AC induction and PMAC motors.

Automatic belt breakage detection - Interactive monitoring of the running conditions of a fan allows AC30 to detect a breakage in the drive belt between the fan and motor, stop the motor and indicate an alarm condition.

Catching a spinning load - "fly-catching" - The fan control algorithms enable the AC30 to detect when a fan is free-wheeling and to regain control of it before running it at the commanded speed.

PID Control - Multiple PID control loops can be programmed to monitor process variables and adjust the speed of the motor accordingly to achieve the required variable setpoint.

Intelligent pump profiles - Our advanced intelligent pump control algorithms monitor motor loads and provides users with a number of features designed specifically for pump control applications.

Essential services (Fire mode) - Selected via digital input, Fire mode will cause the drive to run continuously at the maximum programmed speed ignoring all other control signals and alarm conditions.

Energy optimisation - Under constant speed conditions, the motor power waveforms from the drive are optimised to reduce motor energy consumption without compromising performance.

Skip frequencies - Up to 4 speed and frequency bands can be programmed in the AC30, to enable resonant points on the fan to be avoided, reducing vibration, wear and noise.

Timed run function - 10 daily start/stop events can be programmed with different running speeds across a 7 day period.

Process Timers - Multiple hours-run timers can be programmed to generate text alerts on the drive keypad to coincide with process maintenance intervals.

Multi Axis Applications

The AC30 series is ideal for integration into wide range of applications. The intelligent automation features it provides allow it to be integrated into advanced systems.

Parker Drive Developer (PDD) software for programming of multiple axis software nodes in a single software project. The project source code can be quickly saved to an SD card or with AC30 P&D it can be stored in the internal drive memory. This allows the entire software project to be extracted from the drive on site, modified and re-saved.

AC30P and D include dual ethernet ports to allow for simple peer-to-peer wiring and interconnection into external automation control systems via Modbus TCP/IP, Profinet and Ethernet IP.

AFE operating mode on the AC30P and D for the four quadrant control of a drive system DC link. This is achieved when used in combination with a Pulse Encoder Speed Feedback Option (7004-04-00) connected to an external AFE Line Sync Module (LA471892U001), as the mains synchronisation input.

Peer to Peer 1588 time synchronisation between drive nodes allowing multiple axis to operate seamlessly in a line configuration. Speed following, phase locking and registration are supported with pre configured software functions. The AC30D allows for a real master to be used as a speed reference in the form of an encoder input which can be cascaded via the encoder repeated output or generated by a virtual master.

Speed feedback auto-changeover in case of failure is a new intelligent feature supported by the AC30P/D series. The drive can recognise a fault condition with the encoder feedback by the difference between the speed feedback signal and that of an internal speed estimator. The drive then performs an on-the-fly changeover to sensorless control and provides a warning to the user. This allows production to continue up to a planned stoppage. This feature can maximise production availability and minimise scrap and wastage in many process line applications.

Intelligent diagnostics and data logging allow users to monitor system performance and manage system warnings by taking corrective action before faults or trips occur. Eight user-definable trips can be configured in the application, each with an associated warning and user-definable name. Parameter data may be logged to an SD card, captured with real-time stamps when fitted with the optional RTC card. "Black Box" trip history accurately captures drive status in the lead up to a trip event. This data may be transferred to a readable .csv file on the optional SD card.

SMART brake resistor sharing in common-bus systems is provided so the brake switch is disabled when its IxT limit is reached, but without tripping. Braking voltage level also increases gently as the IxT is accumulated. This approach facilitates better braking energy sharing in distributed resistor systems.



Engineered for any system

The AC30 series is designed to be integrated into any multi-axis drive system. The flexibility of power and control on this modular product allows users to design systems to perfectly match their application.



Parker Drive Quicktool (PDQ) Software

Description

PDQ is a simple software tool for installing, programming and monitoring applications on the AC30 series variable speed drive.

Communication between the drive and PC is via the in-built Ethernet port and the software automatically detects all AC30 drives connected to the Ethernet network.

Once the drive is selected, a simple wizard guides the user through the installation process. Starting with the required application the user is asked to choose their motor data from a motor database or enter their own specific data, to configure the I/O and communications and finally commission the drive. The drive parameters can then be monitored, charted and adjusted.

The drive also supports its own webserver providing access to all drive parameters for quick and easy changes.



Parker Drive Quicktool is shipped with every drive and can also be downloaded for free from the Parker website.
www.parker.com/msgc/software

Parker Drive Developer (PDD) Software

Description

PDD is a fully featured PLC programming tool for the AC30 series variable speed drive, supporting all IEC-61131 languages including ladder logic, structured text and function block diagrams.

It provides access to all drive parameters and enables the user to create powerful AC30 drive solutions. It's also possible to create custom parameters and menus so the user can describe the setup and status of the drive in the context of their own application.

To help start the development process Parker provides pre-installed libraries with the following functionality:

- Basic Speed Control
- Fan and Pump Control
- Winder Blocks
- Cascaded Pump Control

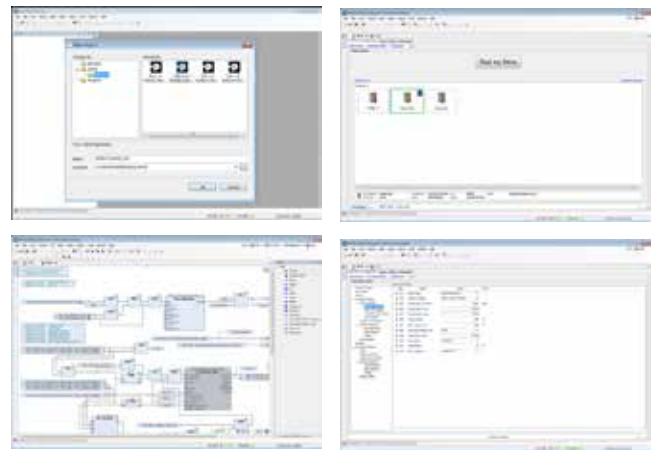

Technical Characteristics

AC30 Power Stack Ratings

Power Stack Order Code	Normal Duty Ratings			Heavy Duty Ratings			Frame
	kW/HP	Output Current A_{rms}		kW/HP	Output Current A_{rms}		
		400 VAC	460 VAC		400 VAC	460 VAC	
380-480 (± 10 %) VAC Supplies Three Phase							
7x0-4D0004-B...	1.1/1.5	3.5	3.0	0.75/1	2.5	2.1	D
7x0-4D0006-B...	2.2/3	5.5	4.8	1.5/2	4.5	3.4	D
7x0-4D0010-B...	4/5	10	7.6	3/4	7.5	5.8	D
7x0-4D0012-B...	5.5/7.5	12	11	4/5	10	7.6	D
7x0-4E0016-B...	7.5/10	16	14	5.5/7.5	12	11	E
7x0-4E0023-B...	11/15	23	21	7.5/10	16	14	E
7x0-4F0032-B...	15/20	32	27	11/15	23	21	F
7x0-4F0038-B...	18/25	38	36	15/20	32	27	F
7x0-4G0045-B...	22/30	45	40	18/25	38	36	G
7x0-4G0060-B...	30/40	60	52	22/30	45	40	G
7x0-4G0073-B...	37/50	73	65	30/40	60	52	G
7x0-4H0087-B...	45/60	87	77	37/50	73	65	H
7x0-4H0105-B...	55/75	105	96	45/60	87	77	H
7x0-4H0145-B...	75/100	145	124	55/75	105	96	H
7x0-4J0180-B...	90/125	180	156	75/100	145	124	J
7x0-4J0205-B...	110/150	205	180	90/125	180	156	J
7x0-4J0260-B...	132/200	260	240	110/150	205	180	J
7x0-4K0315-B...	160/250	315	302	132/200	260	240	K
7x0-4K0380-B...	200/300	380	361	160/250	315	302	K
7x0-4K0440-B...	250/350	440	414	200/300	380	361	K
7x0-4L0530-N...	280/450	530	497	250/400	480	442	L
7x0-4L0590-N...	315/500	590	550	280/450	530	497	L
7x0-4M0650-N...	355/550	650	602	315/500	590	548	M
7x0-4M0700-N...	400/600	700	657	355/550	650	603	M
7x0-4N0790-N...	450/650	790	713	400/600	700	659	N

See Ordering Information for full order codes and description.

Electrical Characteristics

Power Supply	400 V Nominal	
Rated Input Voltage	3 x 380...480 VAC ±10 %	
Input Frequency	45...65 Hz	
Maximum Switching Frequency	2 kHz up to maximum of 12 kHz - de-rating may apply	
Overload: Heavy Duty	150 % for 60 s - 180 % for 3 s (frames D to K)	
Overload: Normal Duty	110 % for 60 s - 180 % of HD FLC. for 3 s (frames D to K)	
Output Frequencies	0...590Hz	0...500 Hz at 4 kHz switching frequency* 0...1000 Hz at 8 kHz switching frequency* 0...1500 Hz at 12 kHz switching frequency*
Earth Leakage Current	>10 mA (all models)	

*Subject to export license agreement

Environmental Characteristics

Operating Temperature	0...+40 °C Normal Duty, 0...+45 °C Heavy Duty. Derate up to a maximum of +50 °C
Storage Temperature	-25...+55 °C
Shipping Temperature	-25...+70 °C
Product Enclosure Rating	IP20 - remainder of surfaces (Europe) UL (c-UL) Open Type (North America/Canada)
(Cubicle mounted)	IP20 UL (c-UL) Open Type (North America/Canada)
(Through-panel mounted)	IP20 UL (c-UL) Open Type (North America/Canada) (frames D to K)
Altitude	1000 m ASL. Derate output by 1 % per 100 m to a maximum of 2000 m
Operating Humidity	Maximum 85 % relative humidity at 40 °C non-condensing
Atmosphere	Non-flammable, non-corrosive and dust free
Climatic Conditions	Class 3k3, as defined by EN60721-3-3
Chemically Active Substances	For the standard product, compliance with EN60271-3-3 is: <ul style="list-style-type: none"> Both classes 3C3 and 3C4 for Hydrogen Sulphide gas (H₂S) at a concentration of 25 ppm for 1200 hours Both classes 3C1 (rural) and 3C2 (urban) for all 9 defined substances as defined in table 4
Operating Vibration	Test Fc of EN60068-2-6 10 Hz<=f<=57 Hz sinusoidal 0.075 mm amplitude 57 Hz<=f<=150 Hz sinusoidal 1 g 10 sweep cycles per axis on each of three mutually perpendicular axis
Overvoltage Category	Overvoltage category III (numeral defining an impulse withstand level)
Pollution Degree	Pollution degree II (non-conductive pollution, except for temporary condensation) for control electronics Pollution Degree III (dirty air rating) for through-panel mounted parts

Standards and Conformance

North America/Canada	Complies with the requirements of UL508C and CSA22.2 #14 as an open-type drive
European LV Directive	This product conforms with the Low Voltage Directive 2006/95/EC
European EMC Directive	CE Marked in accordance with 2004/108/EC
RoHS Compliance	This product complies with RoHS substance restrictions in accordance with EC Directive 2011/65/EU
Reach	This product complies with the REACH regulations EC1907/2006
European Machinery Directive	Safe-Torque-Off (STO) complies with the requirements of ISO13849-1 (Safety-related parts of control systems) at PLe Cat3 or SIL 3 to EN61800-5-2
DNV Marine Certification (Det Norske Veritas)	Complies with the 'Classification of Ships, High Speed & Light Craft and Det Norske Veritas Offshore Standards'. This applies to all AC30 Frequency converters with powers up to 75kW for use in marine and offshore applications

Dimensions

Panel Mounting

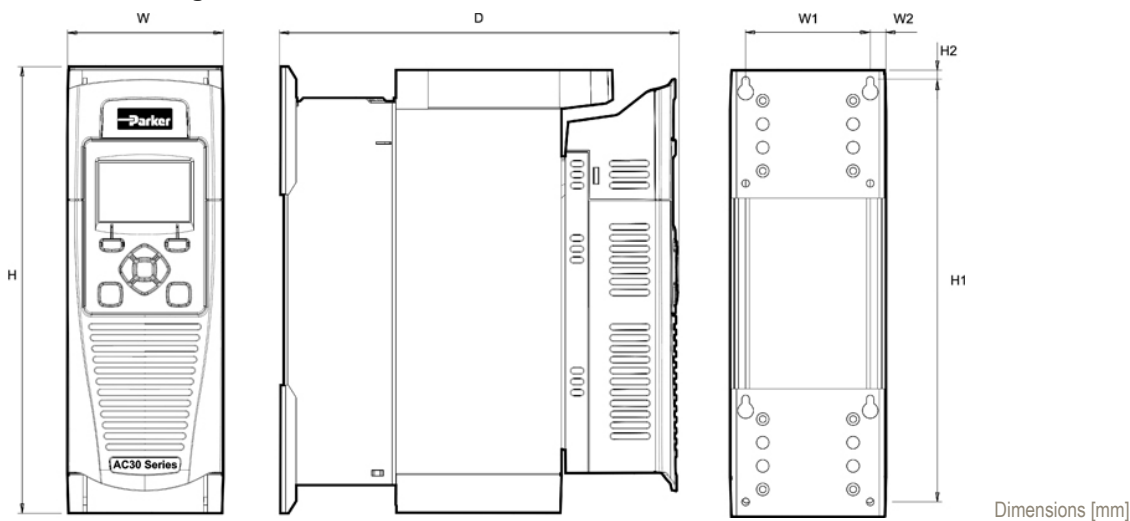

Dimensions [mm]

Model	Max. Weight [kg]	H	H1	H2	W	W1	W2	D	Fixings
Frame D	4.5	286	270	6.5	100	80	10.0	255	Slot 4.5 mm wide. Use M4 fixings
Frame E	6.8	333	320	6.5	125	100	12.5	255	
Frame F	10	383	370	6.5	150	125	12.5	255	
Frame G	22.3	480	465	7.25	220	190	15	287	Slot 5.0 mm wide. Use M5 fixings
Frame H	42.8	670	650	10	260	220	20	331	
Frame J	89	800	780	10	330	285	22.5	374	Use M8 fixings
Frame K	125	1300	1272	14	400	280	60	385	Use M10 fixings
Frame L	182	1340	1310	15	535	470	32	378	Use M10 fixings
Frame M	240	1463	1448	15	604	545	29.5	378	Use M10 fixings
Frame N	266	1593	1563	15	604	545	29.5	378	Use M10 fixings

*The AC30D control module increases the shown depth by 18mm on all frame sizes.

Through Panel Mounting

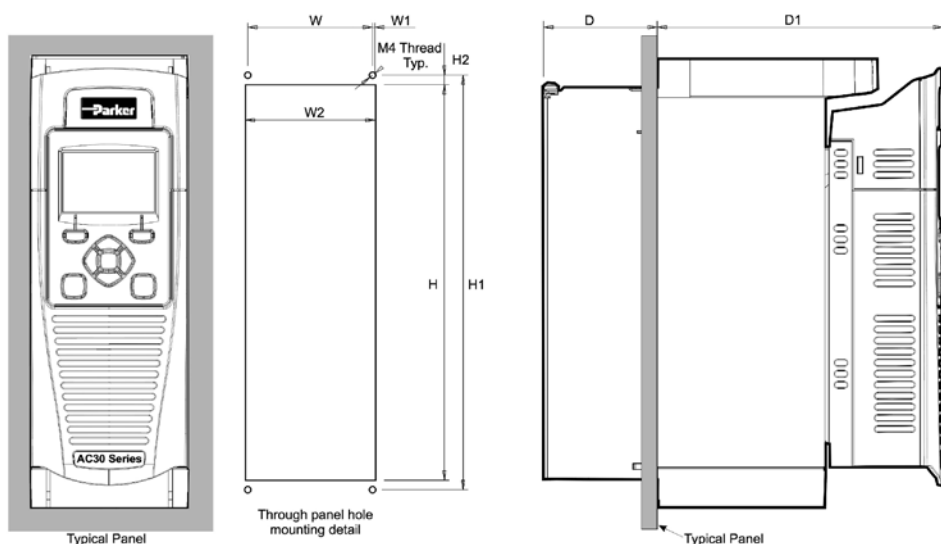

Dimensions [mm]

Model	H	H1	H2	W	W1	W2	D	D1	Fixings
Frame D	250	262	6	79	1.5	82	72	181	Use M4 fixings
Frame E	297	309	6	102	1	104	72	181	
Frame F	347	359	6	127	1	129	72	181	
Frame G	440	455.8	7.9	195	0.4	195.8	95	190	Use M5 fixings
Frame H	617	641	12	218	4.5	227	99	211	Use M6 Fixings
Frame J	745	765	10	275	12.5	300	128	242.6	Use M6 Fixings

Through panel mounting is not possible for frame K to N.

Connections

Power connections

Term.	Description
DB+	Dynamic Brake Resistor
DB-	Dynamic Brake Resistor
DC+	DC Link Bus +Ve
DC-	DC Link Bus -Ve
L1	L1 AC Input Supply
L2	L2 AC Input Supply
L3	L3 AC input Supply
M1	Motor Output 1/U
M2	Motor Output 2/V
M3	Motor Output 3/W

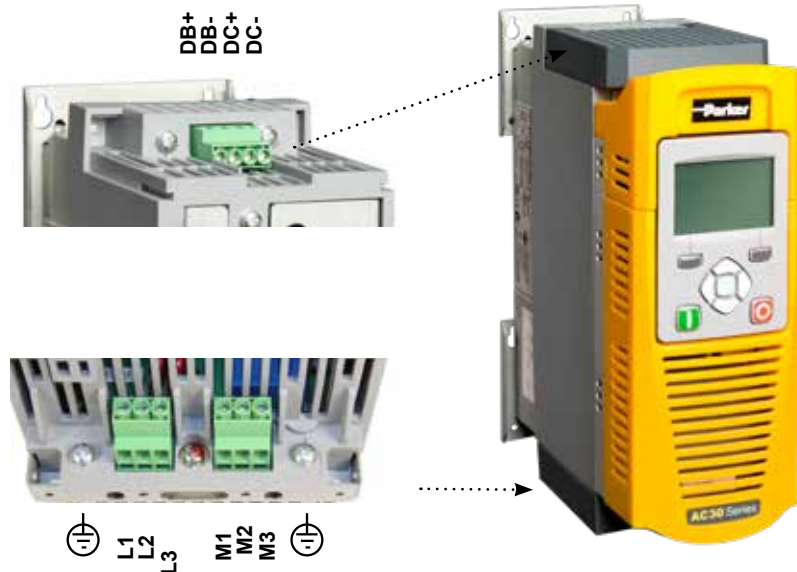

Safe Torque Off (STO)

The AC30 series features Safe Torque Off functionality as standard, offering users protection against unexpected motor start-up in accordance with EN13849-1 at PLe Cat 3 or SIL 3 to EN61800-5-2.

The STO functionality helps protect personnel and machinery by preventing the drive from restarting automatically. It disables the drive pulses and inhibits the power supply to the motor, so that the drive cannot generate any potentially hazardous movement. The state is monitored internally within the drive.

The example wiring diagram shows the minimum connections required to implement STO with the AC30 series AC drives.

Term.	Label	Description
X10/01	STO A Input	STO Channel A input signal
X10/02	STO Common	Return signals for STO A and STO B
X10/03	STO B Input	STO Channel B input signal
X10/04	STO Common	Return signals for STO A and STO B
X10/05	STATUS A	STO Status Indication
X10/06	STATUS B	STO Status Indication

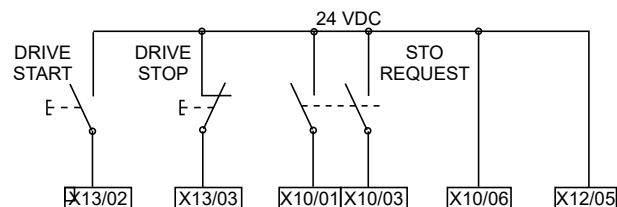

AC30 Series STO

Users must conduct a risk assessment to identify the appropriate STO wiring scheme and ensure that all safety requirements are met.

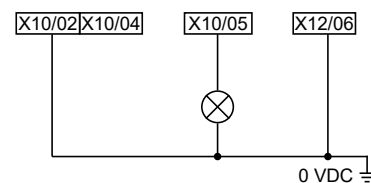

It is the user's responsibility to ensure the safe and correct use of the STO function of the AC30 Series. User's should read and fully understand chapter 6 (Safe Torque Off) of the product user manual downloadable from www.parker.com.

Control wiring connections: AC30V and AC30P

Term.	Label
X10/01	STO A Input
X10/02	STO Common Return
X10/03	STO B Input
X10/04	STO Common Return
X10/05	STO Status A
X10/06	STO Status B
X11/01	ANIN 01 Analogue Input (± 10 V, 0-10 V, 0-20 mA, 4-20 mA)
X11/02	ANIN 02 Analogue Input (± 10 V, 0-10 V)
X11/03	ANOUT 01 Analogue Output (± 10 V, 0-10 V)
X11/04	ANOUT 02 Analogue Output (0-10 V, 0-20 mA, 4-20 mA)
X11/05	+10 V Reference
X11/06	-10 V Reference
X12/01	DIGIN04 / DIGOUT 01 Digital In/Out
X12/02	DIGIN05 / DIGOUT 02 Digital In/Out
X12/03	DIGIN06 / DIGOUT 03 Digital In/Out
X12/04	DIGIN07 / DIGOUT 04 Digital In/Out
X12/05	User +24 V Output
X12/06	0 V Common

Term.	Label
X13/01	0V Common
X13/02	DIGIN 1 Digital Input
X13/03	DIGIN 2 Digital Input
X13/04	DIGIN 3 Digital Input
X13/05	+24 V Auxiliary Input
X13/06	0 V Auxiliary Input
X14/01	Relay Output 01 (Contact A)*
X14/02	Relay Output 01 (Contact B)*
X14/03	Relay Output 02 (Contact A)*
X14/04	Relay Output 02 (Contact B)*

*Relay outputs are not present on AC30P/D. These are replaced by dual ethernet ports.

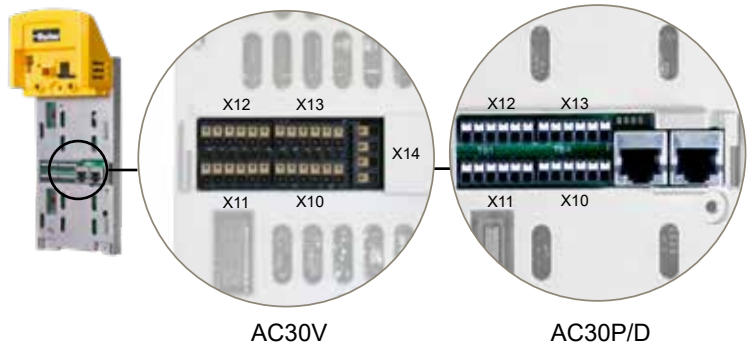

Example for basic speed control wiring diagram

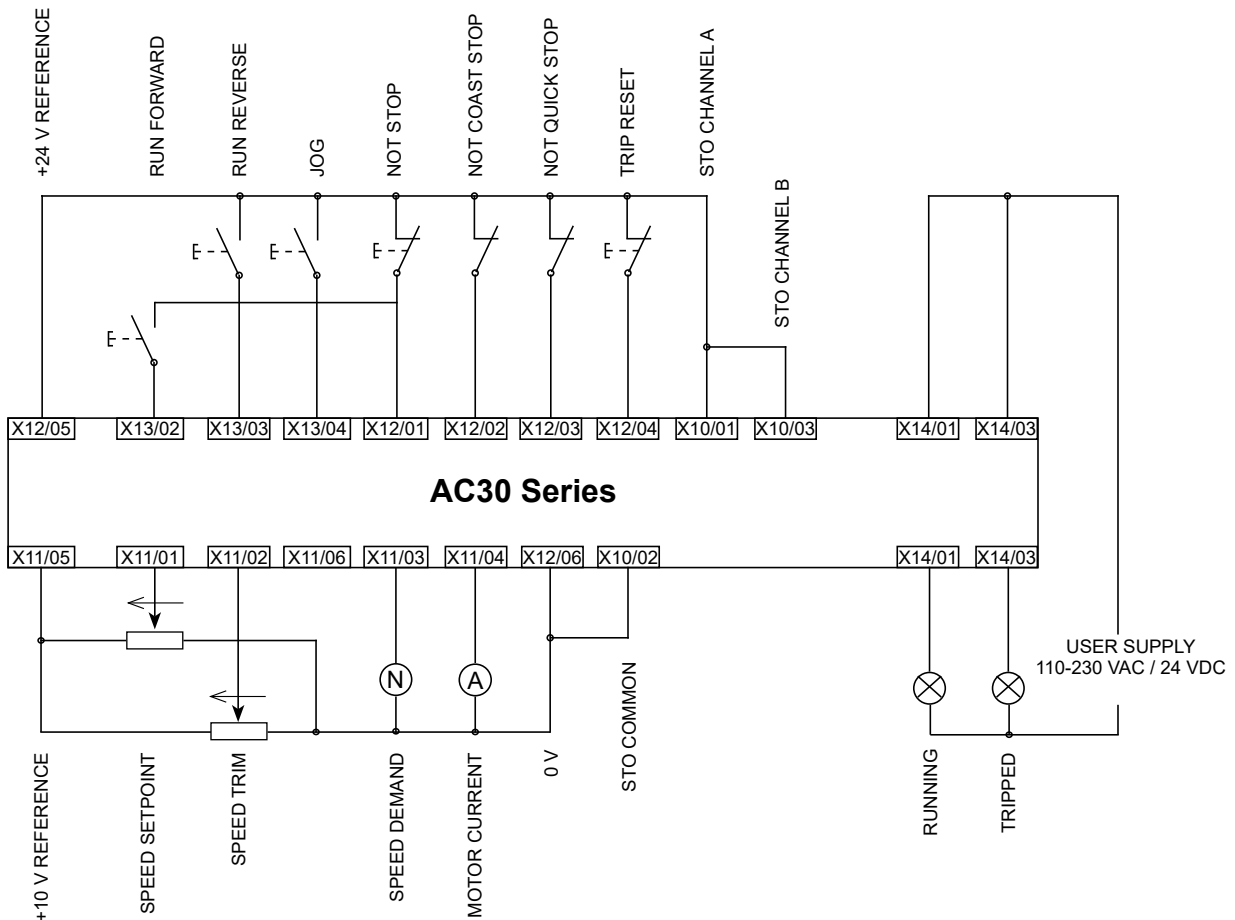

Control wiring connections: AC30D

The wiring on the AC30D is the same as AC30P with the additional systems connections shown below.

Term.	Label	Term.	Label
X30/01	DIGIN 1	X32/01	Encoder 1 - A Input
X30/02	DIGIN 2	X32/02	Encoder 1 - /A Input
X30/03	DIGIN 3	X32/03	Encoder 1 - B Input
X30/04	DIGIN 0V	X32/04	Encoder 1 - /B Input
X30/05	+24V System Aux. Input	X32/05	Encoder 1 - Z Input
X30/06	0V System Aux. Input	X32/06	Encoder 1 - /Z Input
X31/01	Encoder 2 - A Input	X32/07	Encoder PSU Output - Positive Terminal (internally connected to X31/07)
X31/02	Encoder 2 - /A Input	X32/08	Encoder PSU Output - 0V Terminal (internally connected to X31/08)
X31/03	Encoder 2 - B Input	X33/01	Encoder Transmit - A Output
X31/04	Encoder 2 - /B Input	X33/02	Encoder Transmit - /A Output
X31/05	Encoder 2 - Z Input	X33/03	Encoder Transmit - B Output
X31/06	Encoder 2 - /Z Input	X33/04	Encoder Transmit - /B Output
X31/07	Encoder PSU Output - Positive Terminal (internally connected to X32/07)	X33/05	Encoder Transmit - Z Output
X31/08	Encoder PSU Output - 0V Terminal (internally connected to X32/08)	X33/06	Encoder Transmit - /Z Output

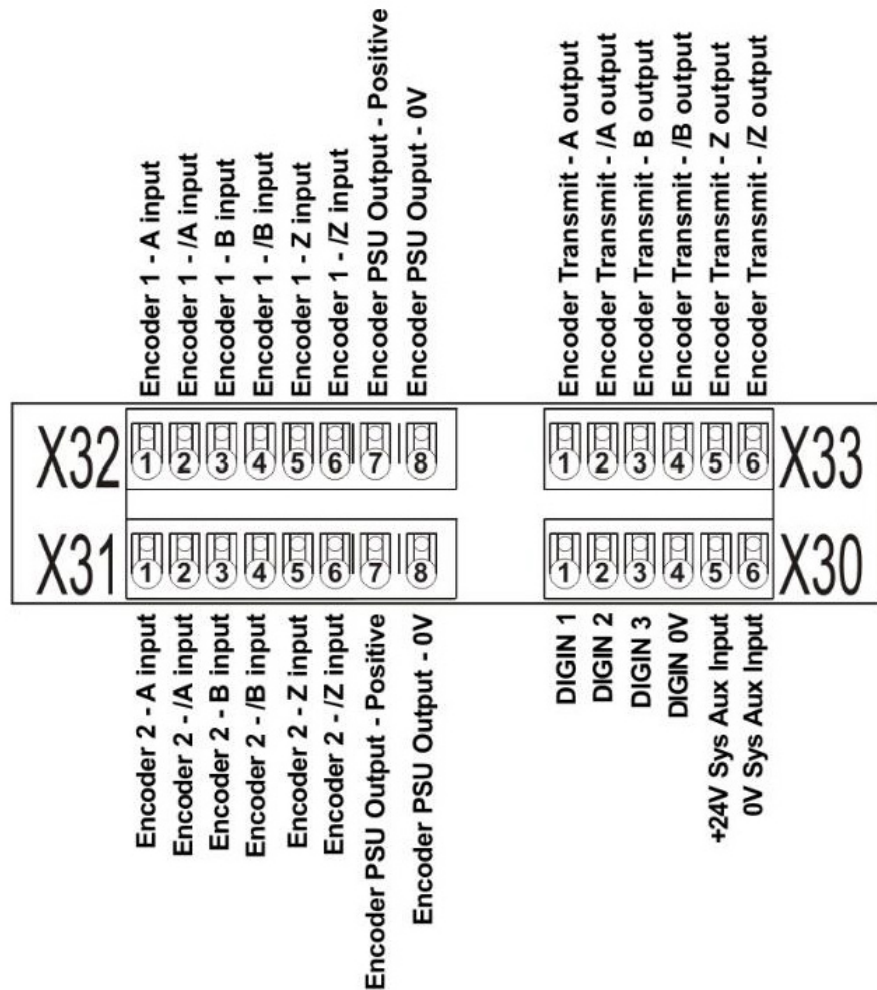
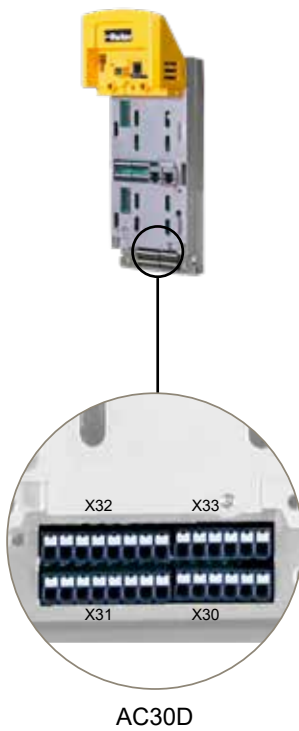

Accessories and Options

Operator Keypad

Order Code	Description
7001-00-00	IP54 Graphical keypad
7001-01-00	Keypad blanking cover
LA501991U300	Keypad remote mounting kit (3 m cable and screws)

Description:

The backlit LCD graphical keypad can be either mounted locally on the drive or remotely with the use of a remote mounting kit. The keypad has 3 pass code protected user access levels. The keypad can be used to set-up and commission the drive, change parameter settings, monitor running status or diagnose warning or alarm conditions. The display information can be shown in English, German, French, Spanish or Italian.



7001-00-00



7001-01-00

Cablescreening Kits

Order Code	Description
LA501935U001-1	Frame D C2 environment filter kit
LA501935U002-1	Frame E C2 environment filter kit
LA501935U003-1	Frame F C2 environment filter kit
LA501935U004-1	Frame G cable screening kit
LA501935U005-1	Frame H cable screening kit
LA501935U006-1	Frame J cable screening kit
LA501935U007-1	30P system board screening kit



LA501935U001-1

The environment filter kit consists of a motor cable ferrite core and screening brackets and is required to comply with the requirements of the EMC directive for a C2 environment with frames D, E and F. For frame G and H the drive has a different EMC internal filter which is required in addition to the screen kit. For frames J to N an external EMC filter is required.

Input and Output Cards

7004-01-00 - General Purpose I/O Module

Digital Inputs & Outputs	4x Digital inputs or outputs
Analogue Inputs/Outputs	2x Analogue inputs (± 10 V)
Relay Outputs	2x Volt-free relay outputs (230 VAC, 30 VDC)
Motor Thermistor Inputs	1x Motor thermistor input
Time Format*	Seconds
Accuracy (drive powered)*	± 1 minute / month (RTC trim=0)
Accuracy (drive unpowered)*	± 5 minutes / month (RTC trim=0)
Battery Backup Duration*	6 Months



Description:

The general purpose I/O (GPIO) option module can be fitted to all AC30 series drives in the upper I/O option module slot. The modules are field-fittable and offer users the opportunity to expand the drives standard I/O capability, allowing more complex motor control solutions to be implemented.

The 7004-01-00 with real-time clock (RTC) adds the ability to program the drive to perform functions at specified times, and enables time stamping of events. The RTC is battery-backed. The battery recharges when the drive is powered.

Connection Details:

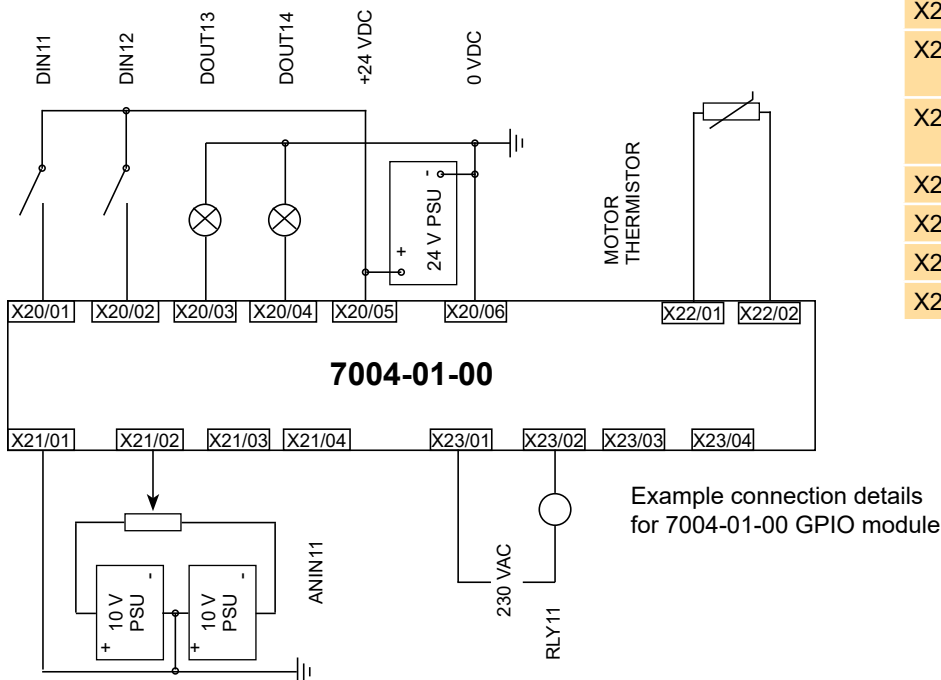

Terminal	Label
X20/01	DIN11/DOUT11
X20/02	DIN12/DOUT12
X20/03	DIN13/DOUT13
X20/04	DIN14/DOUT14
X20/05	+24 VDC
X20/06	0 VDC COMMON
X21/01	REFERENCE
X21/02	ANIN11
X21/03	REFERENCE
X21/04	ANIN12
X22/01	MOTOR THERMISTOR
X22/02	MOTOR THERMISTOR
X23/01	RLY11
X23/02	RLY11
X23/04	RLY12
X23/04	RLY12

7004-02-00 - Motor Thermistor Input Module

Motor Thermistor Inputs	1x Motor thermistor input
Thermistor Compatibility	PTC, NTC, KTY
Thermistor Resistance Range	0...4.5 k Ω

Description:

The isolated motor thermistor input module provides a means of monitoring motor temperature. By default the drive will trip if the motor exceeds a user-defined temperature threshold. All 7004 options with thermistor have the above same specification.



7004-05-00 - Resolver Feedback Module

Maximum Speed	70,000 rpm @ 12-bits
Carrier Output Signal	4-12V rms, 2 kHz - 20 kHz
Maximum Carrier Supply	70mA rms
Maximum Input Voltage	±24V pk differential
Accuracy	<±10 arc min
Resolution	12-16 bits
Inputs	Differential inputs Zin ~ 2.4 kΩ
Isolation	Not isolated



Description:

The resolver feedback module enables a range of resolvers to be connected to the AC30P/D allowing closed-loop control of PMAC motors. The 7004-05-00 is also equipped with a motor thermistor input. The option can also be used to provide a speed reference into any AC30 control module. The resolver module is fully programmable and a range of resolver accessory cables are available.

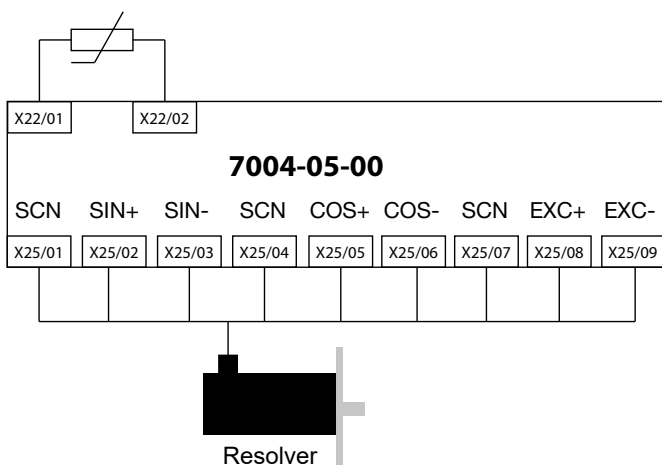

Terminal	Description
X25/01	Cable screen
X25/02	SIN+
X25/03	SIN-
X25/04	Cable screen
X25/05	COS+
X25/06	COS-
X25/07	Cable screen
X25/08	EXC+
X25/09	EXC-
X22/01	Motor thermistor
X22/02	Motor thermistor

7004-04-00 - Pulse Encoder Feedback Module

Maximum Input Frequency	250 kHz per channel
Supply Voltage Output	5 V, 12 V, 15 V, 24 V
Input Format	Quadrature, or Clock (inputs A & /A) and Direction (input B & /B)
Motor Thermistor Details	As 7004-02-00



Description:

The pulse encoder feedback module allows an incremental encoder to be connected to the AC30 allowing users to take full advantage of closed-loop vector control. The 7004-04-00 is also equipped with a motor thermistor input. The option can also be used to provide a speed reference into any AC30 control module.

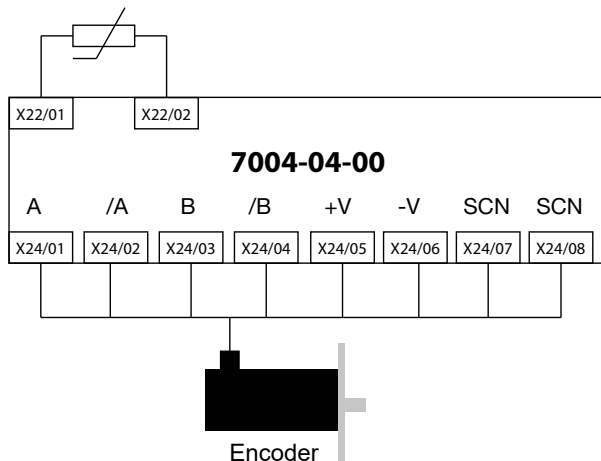

Terminal	Description
X24/01	Channel A
X24/02	Channel /A
X24/03	Channel B
X24/04	Channel /B
X24/05	Supply positive
X24/06	Supply negative
X24/07	Cable screen
X24/08	Cable screen
X22/01	Motor thermistor
X22/02	Motor thermistor

Communication Interfaces

7003-PB-00	PROFIBUS DP-V1 communication interface
Supported Protocols	PROFIBUS-DP; Demand data and Data exchange
Communication Speed	Up to 12 Mbits/s; automatically detected
Max. number of devices	32 per segment, 126 total
Supported Messages	Up to 152 bytes cyclic I/O, 68 bytes class 1 and 2 acyclic data, 152 bytes configuration data. GSD file provided



7003-CB-00	CANopen communication interface
Profile	DS301 V4.02
Communication Speed	10 k, 20 k, 50 k, 125 k, 250 k, 500 k, 1 Mbits/s or automatically detected
Max. number of devices	127
Supported Messages	SDO, PDO, NMT, SYNC



7003-PN-00	PROFINET I/O communication interface
Supported Protocols	PROFINET I/O Real-Time (RT) Protocol
Communication Speed	100 Mbits/s full duplex
Max. number of devices	Virtually unlimited
Supported Messages	Up to 256 bytes of cyclic I/O in data in each direction



7003-IP-00	Ethernet IP communication interface
Supported Protocols	Ethernet IP
Communication Speed	10/100 Mbits/s full/half duplex
Max. number of devices	Virtually unlimited
Supported Messages	Up to 256 bytes of consumed data and 256 bytes of produced data, CIP parameter object support, Explicit messaging



7003-RS-00	RS485 / Modbus RTU communication interface
Supported Protocols	Modbus RTU
Communication Speed	1200 to 115200 bits/s
Max. number of devices	247
Supported Messages	Up to 256 bytes of cyclic I/O data in each direction



7003-EC-00	EtherCAT communication interface
Supported Protocols	CANopen over EtherCAT (CoE) DS301 compliant
Communication Speed	100 Mbits/s
Max. number of devices	65534
Supported Messages	SDO, PDO, NMT, SYNC



Braking Resistors

These resistor sets are designed for stopping the system at rated power. Rated for 10 seconds in a 100 seconds duty cycle. They are metal-clad resistors and should be mounted on a heatsink (back panel) and covered to prevent injury from burning.



Brake resistor selection

Brake resistor assemblies must be rated to absorb both peak braking power during deceleration and the average power over the complete cycle.

$$\text{Peak braking power} = \frac{0.0055J \times (n_1^2 - n_2^2)}{t_b} \text{ (W)}$$

$$\text{Average braking power } P_{av} = \frac{P_{pk} \times t_b}{t_c}$$

J: total inertia [kgm²]
n₁: initial speed [min⁻¹]
n₂: final speed [min⁻¹]
t_b: braking time [s]
t_c: cycle time [s]

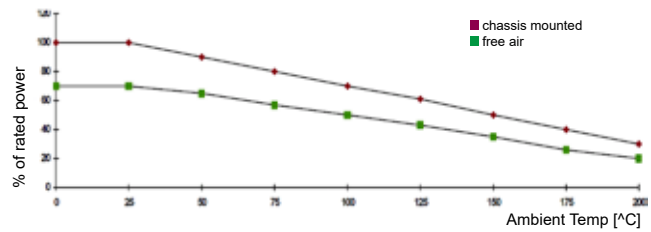

Resistors above 500 W

Resistors above 500 W are available upon request :

- IP20 protection up to 3 kW
- IP13 protection between 4.2 and 9.8 kW

Model	Impedance [Ω]	Nom. Power [W]	Dimensions [mm]							
			L1	L2	L3	W	H	D	a	b
CZ467715	500	60	100	87	60	22	41	4.3	10	12
CZ467714	200	100	165	152	125	22	41	4.3	10	12
CZ389853	100	100	165	152	125	22	41	4.3	10	12
CZ467717	100	200	165	146	125	30	60	4.3	13	17
CZ463068	56	200	165	146	125	30	60	4.3	13	17
CZ388396	36	500	335	316	295	30	60	4.3	13	17
CZ467716	56	500	335	316	295	30	60	4.3	13	17

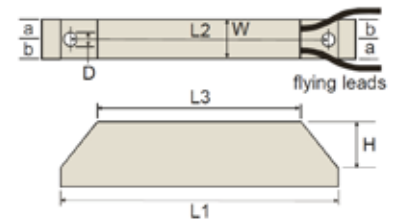

Overload 5 s : 500 %
Overload 3 s : 833 %
Overload 1 s : 2500 %

AC30 Series Product Configuration

The AC30 is a modular product allowing users to select the correct power stack, control module and options to perfectly match their application. Simply select the required parts to build a product bill of materials that meets your requirements. Minimum required parts to build a complete drive is one control module and one power stack.

Control Modules

1	Device Family
30	AC30 series control module only
2	Performance
V	Standard controller
P	Advanced controller
D	Advanced controller with dual encoder system option
3	Graphical Keypad
1	Blanking cover fitter
2	Graphical keypad fitted
4	Environmental Coating
S	Standard 3C3 coating
8	Special Options
0000	No special options



AC30V Control Module



AC30P Control Module



AC30D Control Module

Accessories

Graphical Keypad

Order Code	Description
7001-00-00	Graphical keypad for local or remote mounting
7001-01-00	Keypad blanking cover
LA501991U300	Keypad remote mounting kit (3 m cable and screws)



Communication Interfaces

Order Code	Description
7003-PB-00	Profibus DPV1
7003-PN-00	Profinet IO
7003-CB-00	CANopen
7003-IP-00	Ethernet IP
7003-EC-00	EtherCAT
7003-RS-00	RS485/Modbus RTU



I/O Options

Order Code	Description
7004-01-00	General purpose I/O module
7004-02-00	Motor thermistor input module
7004-04-00	Pulse encoder feedback module
7004-05-00	Resolver feedback module



Power Stack Order Code

	1	2	3	4	5	6	7	8
Order example	710	4	D	0004	B	F	0	S

1 Device Family	710	AC Power stack only (no control module)
2 Voltage	4	400 V nominal
3 Frame Size and Current Rating		(normal / heavy duty)
	D0004	1.1 kW / 0.75 kW
	D0006	2.2 kW / 1.5 kW
	D0010	4 kW / 3 kW
	D0012	5.5 kW / 4 kW
	E0016	7.5 kW / 5.5 kW
	E0023	11 kW / 7.5 kW
	F0032	15 kW / 11 kW
	F0038	18.5 kW / 15 kW
	G0045	22 kW / 18.5 kW
	G0060	30 kW / 22 kW
	G0073	37 kW / 30 kW
	H0087	45 kW / 37 kW
	H0105	55 kW / 45 kW
	H0145	75 kW / 55 kW
	J0180	90 kW / 75 kW
	J0205	110 kW / 90 kW
	J0260	132 kW / 110 kW
	K0315	160 kW / 132 kW
	K0380	200 kW / 160 kW
	K0440	250 kW / 200 kW
	L0530	280 kW / 250 kW
	L0590	315 kW / 280 kW
	M0650	355 kW / 315 kW
	M0700	400 kW / 355 kW
	N0790	450 kW / 400 kW

4 Brake Switch	B	Brake switch fitted (frames D to K)
	N	No brake switch fitted (frames L, M, N)
5 EMC Filter ⁽¹⁾	N	No filter fitted
	E	Category C3 filter fitted
	F	Category C2 filter fitted
6 Graphical Keypad	0	No keypad fitted
7 Environmental Coating	S	Standard 3C3 coating
8 Special Options	0000	No special options

⁽¹⁾ 710 device only :
Category C3 filter fitted as standard for frames D to N only.
Category C2 filter for frames D to H only. For other frames use external EMC filter



Order code 710...
Power Stack Only

EXAMPLE: AC30 Series Product Configuration

The below example shows a product configuration 'bill of materials' for a customer who requires control of a 45 kW motor. The application is to control an extruder, requiring closed-loop vector control with 110% overload and connection via profibus to a PLC. Parker recommends the AC30P control module for this application.

Part Number	Quantity	Description
30P-2S-0000	1	Control module with graphical keypad and standard coating
7003-PB-00	1	Profibus option module
7004-04-00	1	Pulse encoder feedback card
710-4H-0087-BE-0S-0000	1	45 kW AC input power stack with brake switch and C3 EMC filter

AC30V Product Order Code

The AC30V is designed for simple, single-axis applications. To allow customers to quickly select the complete drive to match their application, we have made the AC30V available to order under a single product number. This product code includes one power stack and one control module. Option modules must still be ordered separately.

	1	2	3		4	5	6	7	8
Order example	31V	4	D	0004	B	F	2	S	0000

1 Device Family	31V AC30 Series complete drive	4 Brake Switch ⁽¹⁾	B Brake switch fitted (standard)
2 Voltage	4 400 V nominal	5 EMC Filter ⁽²⁾	N No filter fitted
3 Frame Size and Current Rating (normal / heavy duty)	D0004 1.1 kW / 0.75 kW	E Category C3 filter fitted (standard)	F Category C2 filter fitted
	D0006 2.2 kW / 1.5 kW	6 Graphical Keypad	2 Graphical keypad fitted
	D0010 4 kW / 3 kW	7 Environmental Coating ⁽³⁾	S Standard 3C3 coating
	D0012 5.5 kW / 4 kW	8 Special Options	0000 No special options
	E0016 7.5 kW / 5.5 kW		
	E0023 11 kW / 7.5 kW		
	F0032 15 kW / 11 kW		
	F0038 18.5 kW / 15 kW		
	G0045 22 kW / 18.5 kW		
	G0060 30 kW / 22 kW		
	G0073 37 kW / 30 kW		
	H0087 45 kW / 37 kW		
	H0105 55 kW / 45 kW		
H0145 75 kW / 55 kW			
J0180 90 kW / 75 kW			
J0205 110 kW / 90 kW			
J0260 132 kW / 110 kW			

⁽¹⁾ Drives include brake switch as standard. For non-brake options please contact ssdedcs@parker.com

⁽²⁾ The choice of filter should be determined by the environment in which the drive will be installed as defined in IEC/EN61800-3 C2 = domestic & commercial, C3 = industrial

⁽³⁾ AC30 is conformally coated as standard for use in environments class 3C3 and 3C4 for Hydrogen Sulphide gas. It is also compliant to both classes 3C1 (rural) and 3C2 (urban) for all nine substances defined in table 4 in EN60271-3-3 C2 filter only offered on frames D-H. For other frames use external EMC filter

www.parker.com



European Headquarters
La Tuilière 6, 1163 Etoy,
Switzerland
Tel: +41 21 821 85 00

Your authorized Distributor